

STT116GK22

Thyristor-Thyristor Modules

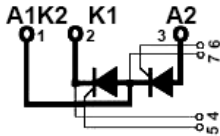

Type	V_{RSM} V_{DSM} V	V_{RRM} V_{DRM} V
STT116GK08	900	800
STT116GK12	1300	1200
STT116GK14	1500	1400
STT116GK16	1700	1600
STT116GK18	1900	1800
STT116GK20	2100	2000
STT116GK22	2300	2200

Dimensions in mm (1mm=0.0394")

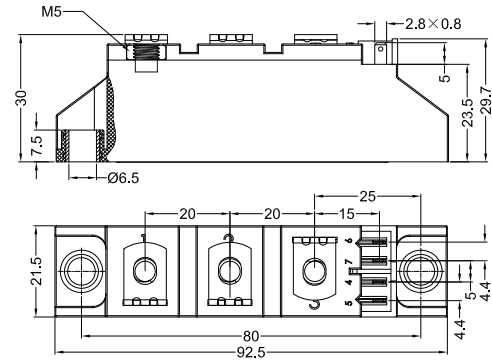

Symbol	Test Conditions	Maximum Ratings	Unit
I_{TRMS} , I_{FRMS} I_{TAVM} , I_{FAVM}	$T_{VJ}=T_{VJM}$ $T_C=85^\circ\text{C}$; 180° sine	180 116	A
I_{TSM} , I_{FSM}	$T_{VJ}=45^\circ\text{C}$ $V_R=0$ $t=10\text{ms}$ (50Hz), sine $t=8.3\text{ms}$ (60Hz), sine	2250 2400	A
	$T_{VJ}=T_{VJM}$ $V_R=0$ $t=10\text{ms}$ (50Hz), sine $t=8.3\text{ms}$ (60Hz), sine	2000 2150	
$\int i^2 dt$	$T_{VJ}=45^\circ\text{C}$ $V_R=0$ $t=10\text{ms}$ (50Hz), sine $t=8.3\text{ms}$ (60Hz), sine	25300 23900	A^2s
	$T_{VJ}=T_{VJM}$ $V_R=0$ $t=10\text{ms}$ (50Hz), sine $t=8.3\text{ms}$ (60Hz), sine	20000 19100	
$(di/dt)_{cr}$	$T_{VJ}=T_{VJM}$ $f=50\text{Hz}$, $t_p=200\mu\text{s}$ $V_D=2/3V_{DRM}$ $I_G=0.45\text{A}$ $di_G/dt=0.45\text{A}/\mu\text{s}$ repetitive, $I_T=250\text{A}$	150	A/ μs
	non repetitive, $I_T=I_{TAVM}$	500	
$(dv/dt)_{cr}$	$T_{VJ}=T_{VJM}$; $R_{GK}=\infty$; method 1 (linear voltage rise) $V_{DR}=2/3V_{DRM}$	1000	V/ μs
P_{GM}	$T_{VJ}=T_{VJM}$ $I_T=I_{TAVM}$ $t_p=30\mu\text{s}$ $t_p=300\mu\text{s}$	10 5	W
P_{GAV}		0.5	W
V_{RGM}		10	V
T_{VJ} T_{VJM} T_{stg}		-40...+125 125 -40...+125	$^\circ\text{C}$
V_{ISOL}	50/60Hz, RMS $I_{ISOL}\leq 1\text{mA}$ $t=1\text{min}$ $t=1\text{s}$	3000 3600	V~
M_d	Mounting torque (M5) Terminal connection torque (M5)	2.5-4.0/22-35 2.5-4.0/22-35	Nm/lb.in.
Weight	Typ.	90	g

STT116GK22

Thyristor-Thyristor Modules

Symbol	Test Conditions	Characteristic Values	Unit
I_{RRM}, I_{DRM}	$T_{VJ}=T_{VJM}; V_R=V_{RRM}; V_D=V_{DRM}$	5	mA
V_{TM}	$I_{TM}=330A; T_{VJ}=25^{\circ}C$	1.65	V
V_{TO}	For power-loss calculations only ($T_{VJ}=125^{\circ}C$)	0.8	V
r_T		2.4	m Ω
V_{GT}	$V_D=6V; T_{VJ}=25^{\circ}C$ $T_{VJ}=-40^{\circ}C$	2.5 2.6	V
I_{GT}	$V_D=6V; T_{VJ}=25^{\circ}C$ $T_{VJ}=-40^{\circ}C$	150 200	mA
V_{GD}	$T_{VJ}=T_{VJM}; V_D=2/3V_{DRM}$	0.2	V
I_{GD}		10	mA
I_L	$T_{VJ}=25^{\circ}C; t_p=10\mu s; V_D=6V$ $I_G=0.45A; di_G/dt=0.45A/\mu s$	450	mA
I_H	$T_{VJ}=25^{\circ}C; V_D=6V; R_{GK}=\infty$	200	mA
t_{gd}	$T_{VJ}=25^{\circ}C; V_D=1/2V_{DRM}$ $I_G=0.45A; di_G/dt=0.45A/\mu s$	2	μs
t_q	$T_{VJ}=T_{VJM}; I_T=150A; t_p=200\mu s; -di/dt=10A/\mu s$ $V_R=100V; dv/dt=20V/\mu s; V_D=2/3V_{DRM}$	185	μs
Q_s	$T_{VJ}=T_{VJM}; I_T, I_F=50A; -di/dt=6A/\mu s$	170	μC
I_{RM}		45	A
R_{thJC}	per thyristor/diode; DC current per module	0.22 0.11	K/W
R_{thJK}	per thyristor/diode; DC current per module	0.42 0.21	K/W
d_s	Creeping distance on surface	12.7	mm
d_A	Strike distance through air	9.6	mm
a	Maximum allowable acceleration	50	m/s^2

FEATURES

- * International standard package
- * DBC baseplate
- * Glass passivated chips
- * Isolation voltage 3600 V
- * UL file NO.310749
- * RoHs compliant

APPLICATIONS

- * DC motor control
- * Softstart AC motor controller
- * Light, heat and temperature control

ADVANTAGES

- * Space and weight savings
- * Simple mounting with two screws
- * Improved temperature and power cycling
- * Reduced protection circuits



Sirectifier®

STT116GK22

Thyristor-Thyristor Modules

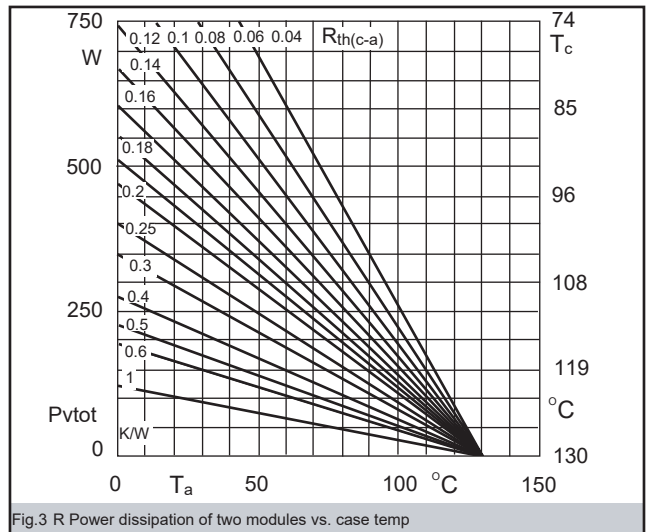
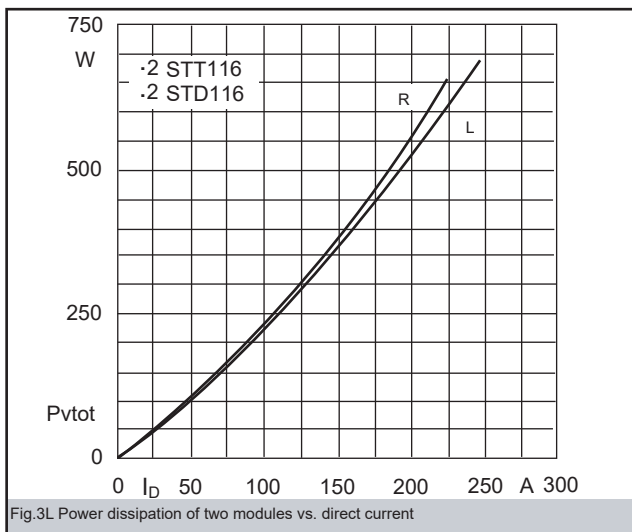
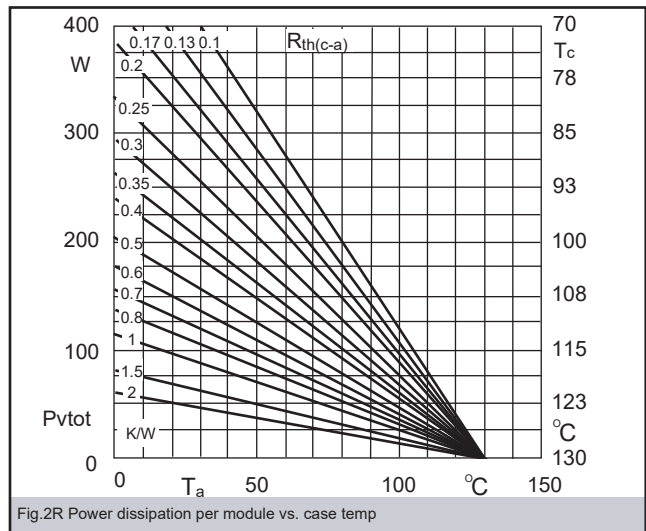
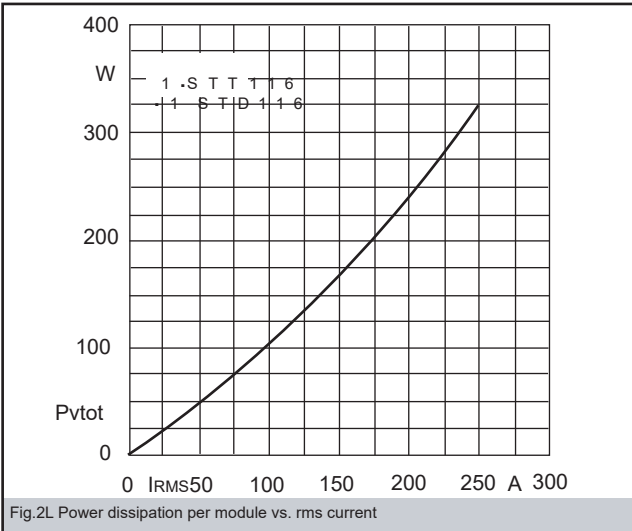
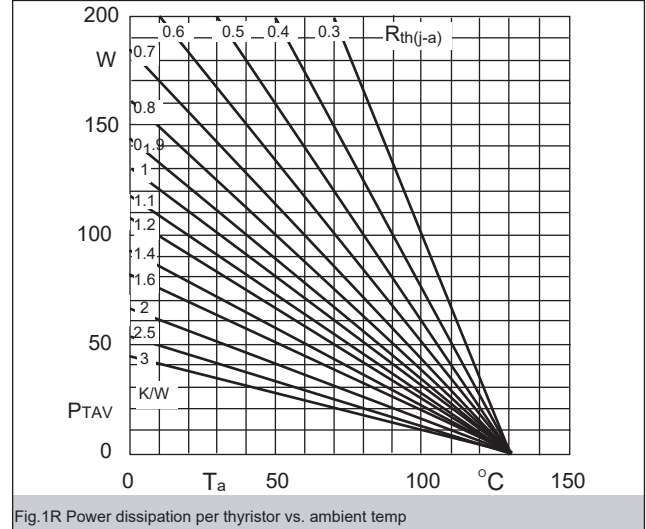
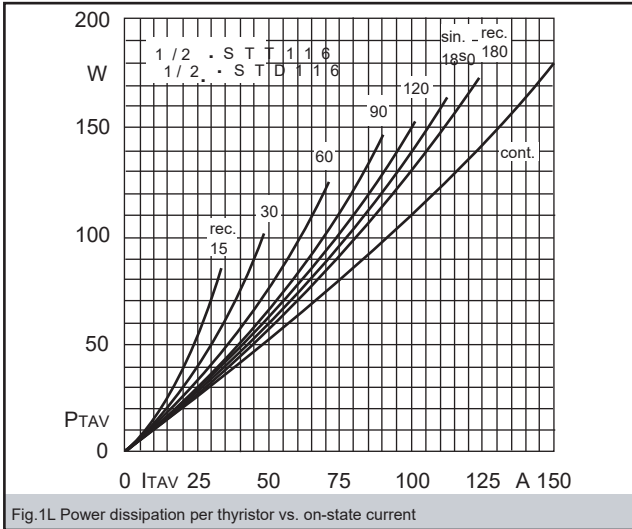

STT116GK22

Thyristor-Thyristor Modules

